

MORSETTIERA 40x16

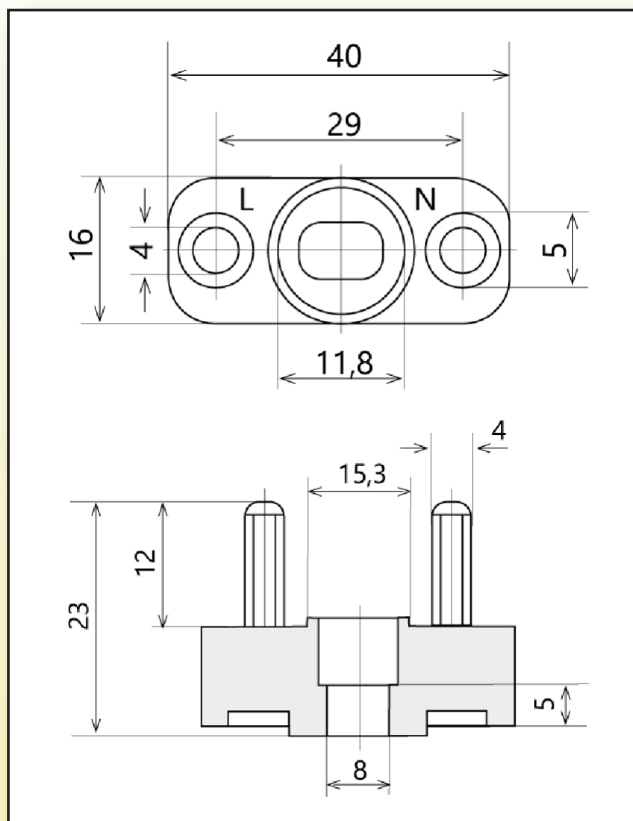

Misure	40x16 mm
Materiali	Ottone
Perni	2 perni fissi a base cilindrica
Accessori	4 dadi + 4 rondelle
Classe termica	F (150°C)
Certificazioni	UL - CSA



RD
&
Components S.r.l.

Via Bergamo 6 - 20835 Muggiò(MB) ITALY
Tel. +39 039 2328773 P.IVA 12934630158
www.rdcomponents.com - www.rdc-service.it

RD
&
Service