

MORSETTIERA 70x45

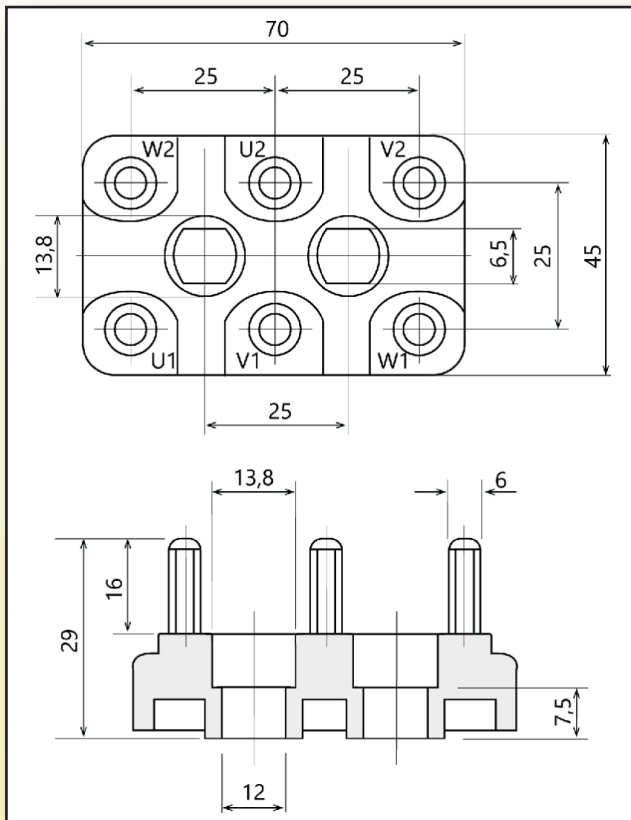

Misure	70x45 mm
Materiali	Ottone
Perni	6 perni fissi a base cilindrica
Accessori	12 dadi + 12 rondelle + 3 ponti
Classe termica	F (150°C)
Certificazioni	UL - CSA

